

b o r pan[®]

sustainable energy solutions for a better world

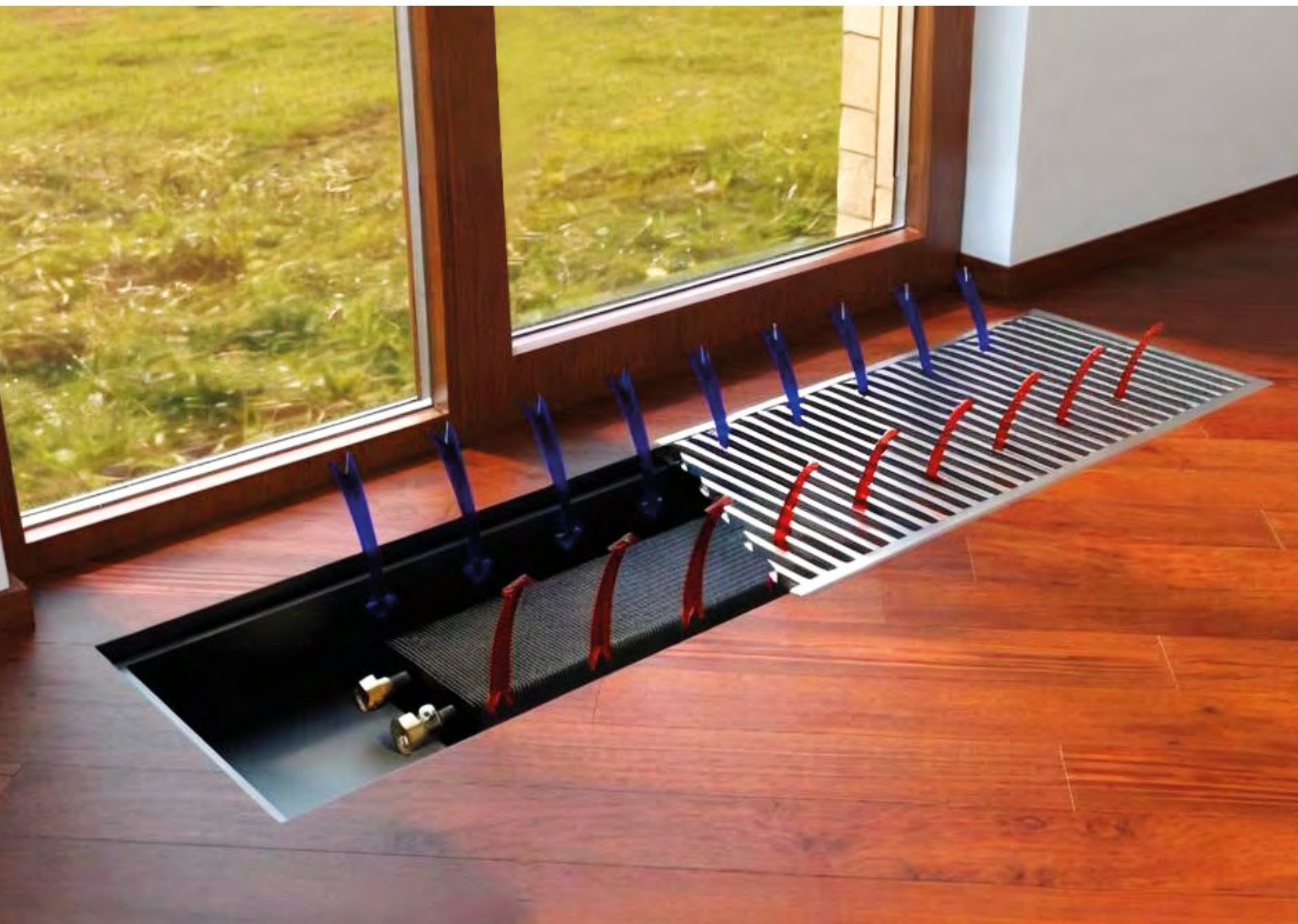

FLOOR CONVECTOR

Sustainable energy solutions for a better world

BORPAN, a brand of BEDISA Inc. Co., is one of the Türkiye's leading manufacturers. With the latest production technology available in the world, our plant covers 42.500 m² indoor area on a 80.000 m² outdoor area located in Aksaray Organized Industrial Zone.

BORPAN specializes in the following HVAC products;

- Hydronic, Electric and Heat Pump Panel Radiators
- Water Heaters and Storage Tanks
- Underfloor Heating Systems
- Room Thermostat and Accessories
- Heat Interface Units
- Floor Convectors
- Towel & Design Radiators
- Valves and Fittings

BORPAN exports to over 60 countries across 6 continents and maintains an extensive dealer network across many throughout Türkiye.

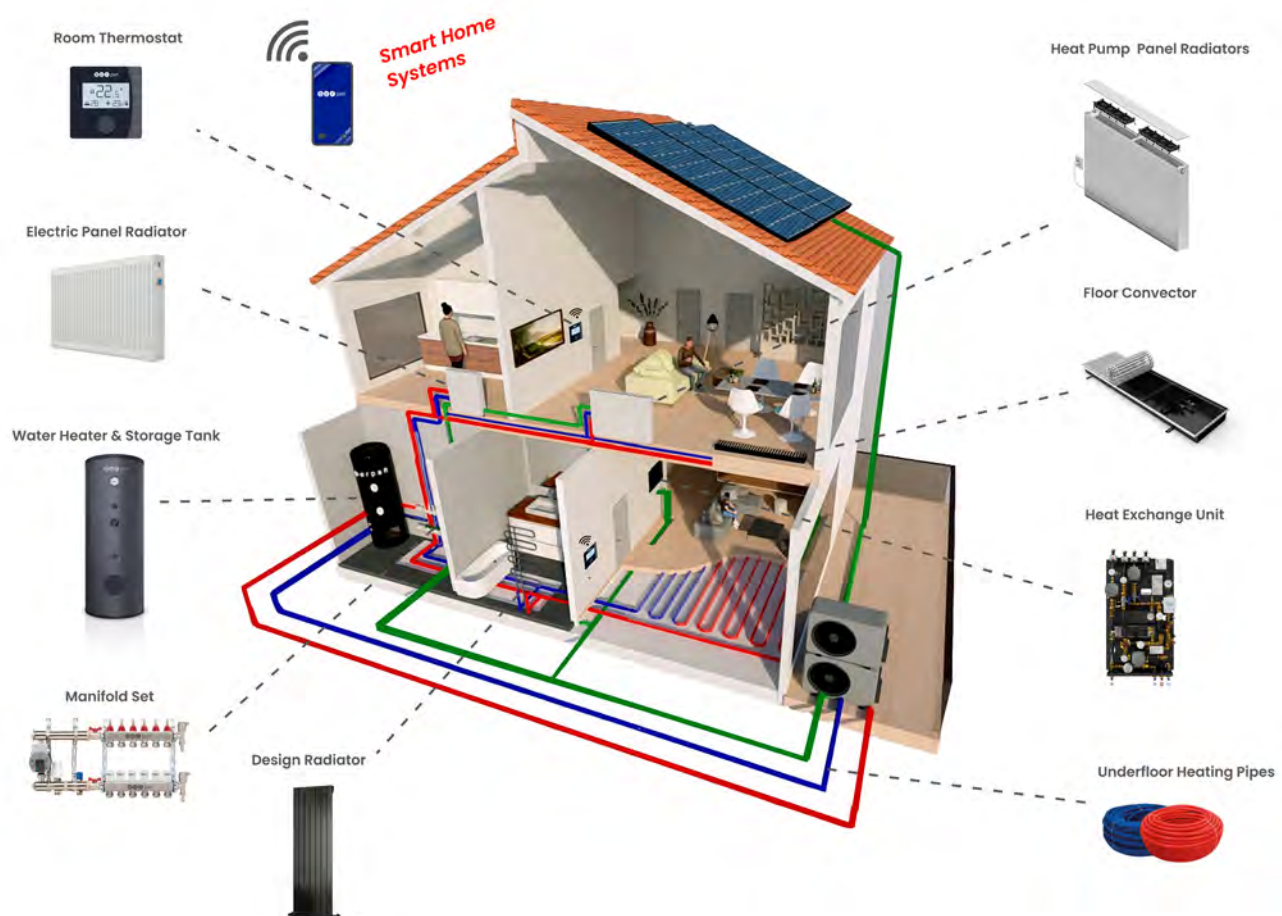

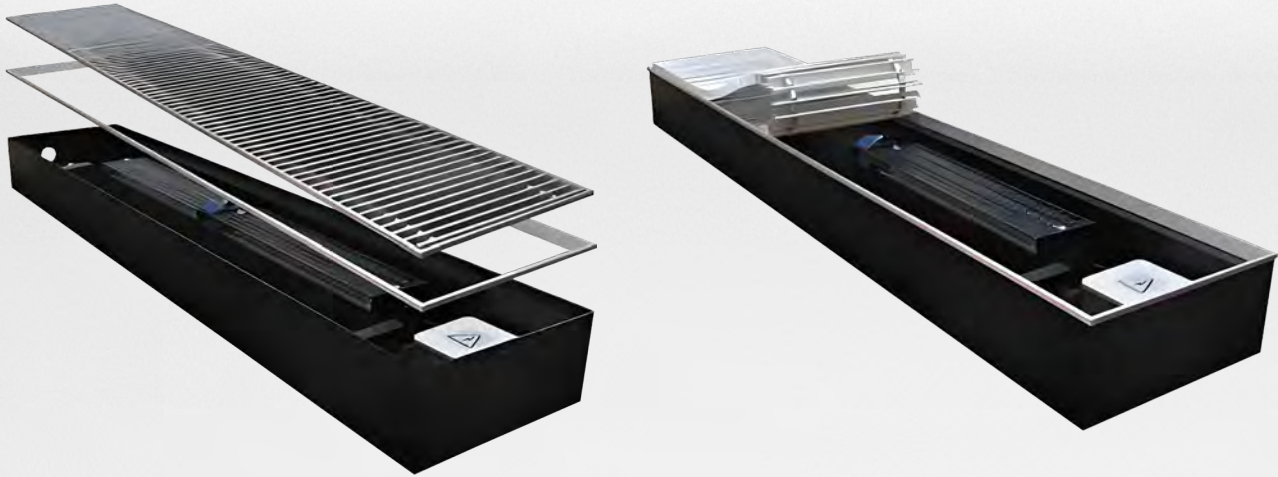

FLOOR CONVECTOR

The floor convectors are the modern heating equipments that are used as the primary or secondary heating system. As a secondary heating system, they can be used in compliance with radiator, central heating system and air handling units etc. they can be used in the places such as showrooms, winter gardens, closed-top swimming pools, gymnasiums, business centers, houses and especially in anywhere having glass facades, in order to increase the comfort conditions. The natural convection type floor convectors' working is based on the natural air function principle. They are used secondarily in zonal heating in order to avoid the heat loss and steam appear on the glass surface. Forced convection type floor convectors can be designed as the primary or secondary heating system. They are used mostly to avoid the heat exchange caused by glass. They create air curtain on the glass surface by heated air.

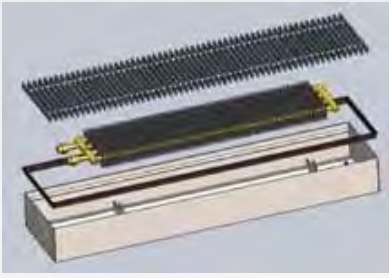

Natural convection type floor convectors can be used in showrooms, winter gardens, closed-top swimming pools, gymnasiums, business centers, houses, and especially in anywhere having glass facades, in order to increase the comfort conditions. It consists of aluminium casing, copper pipe-aluminium bladed coil, linear grille that is parallel to short edge or long edge and frame.



Generally as a secondary heating system depending upon the heating needs of the environment, it can bring the environment to the required comfort conditions. They can be placed in front of the windows in the places heated by radiator or central heating system.



In glass facades, by being used in front of the windows where the most of heat loss of the environment is happened, it helps heating the environment and avoids the steam appear on the glass surface. It can be used thermostatic or motorised vain in coil entrance. The room temperature can be stabilised in the desired degrees by room thermostad by using motorised vain where there are more than one vain in the same zone.



Depending on the building architecture, angular application is available. Angular application can be used for 45° and 90° as well as any value between 90°-179°.



The natural and forced convection floor convectors can be produced in curved shape in order to provide support for architectural needs. They enable also making special designs with a variety of linear grilles.



They can be used in all kind of applications especially because of linear grille's endurance that is parallel to short side and you can move on them securely . Convector casing is made of aluminium material that is highly resistant to corrosion.

ANGULAR APPLICATION

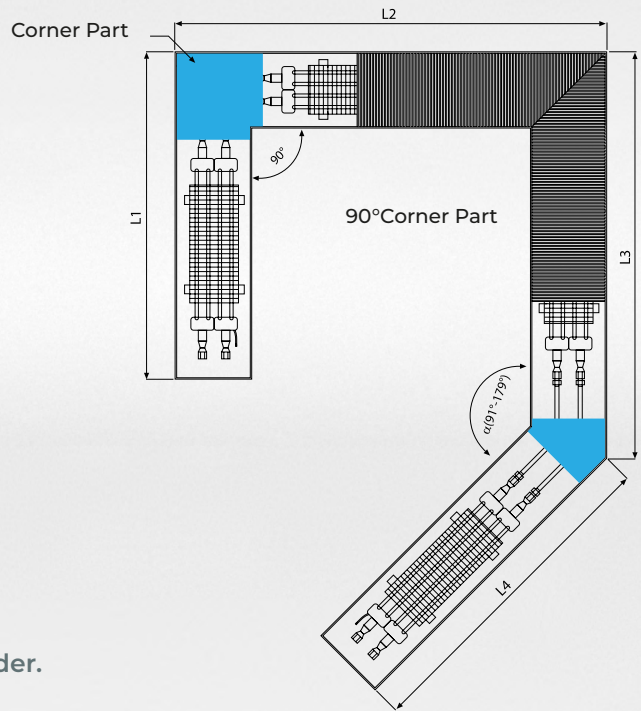

L dimensions and α angles must be specified by order.

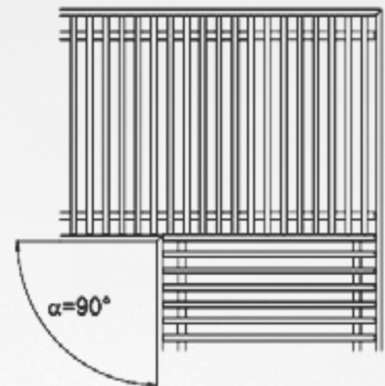
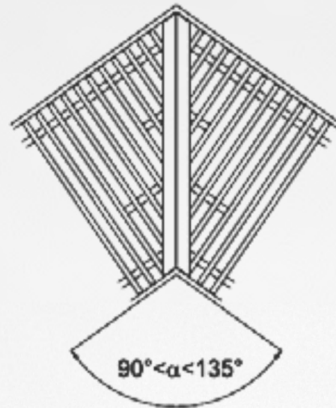
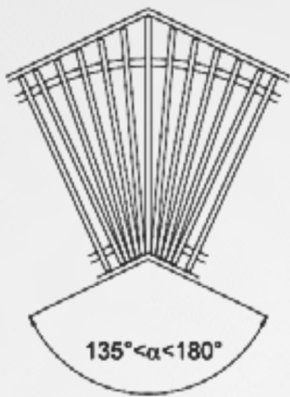

CURVED APPLICATION

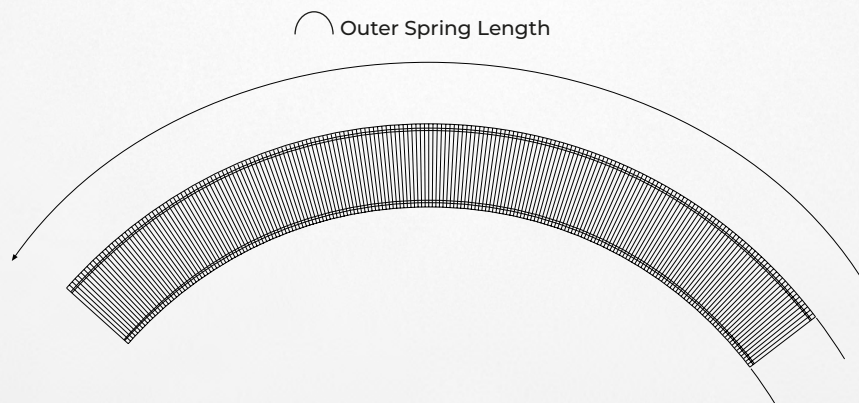

Application projects must be sent to us at the order stage.

K31
K32
K33



Casing

It is made of aluminium that is highly resistant to corrosion in accordance with Etial 60 standards. It is matt black anodised standardly.



Level Definition Screw

There are level definition screws inside of every convector casing, in order to provide applicational simplicity. Level definition screws with a defined distance between each other and each corner can be controlled by Allen key.



Linear Grille

It is made of aluminium profiles with their high resistant design. It conforms Etial 60 standards and it is standardly anodised aluminium. It can be powder-coated with the requested Ral colors upon request or can be anodised differently. It is possible also wooden applications of the convector's linear grille. Linear grille application can be parallel to short edge either to the long edge.



Wooden Linear

Wooden linear applications can be preferred to achieve a warmer appearance and to integrate with architecture. It can be used as natural wood material, specially polished or natural wood with desired colours and textures.



Stainless Steel Linear

In special applications, linear options from various stainless profiles can be preferred.



Frame

In all convectors, frame application can be made in two different sections. The frame to be used can be the same colour as the linear grille used or different colour options can be applied. With the 18mm frame option, clean application is provided in problematic floor installations.

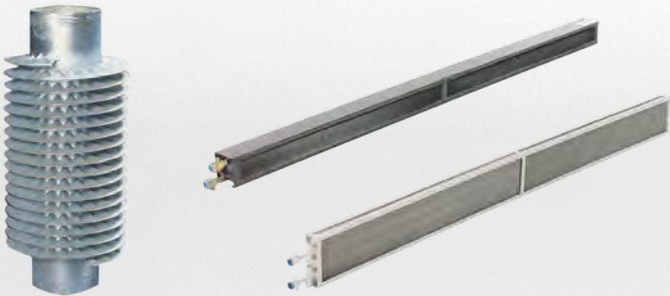

Coil

It is used in natural or forced convection floor convectors, copper pipe, aluminium blade convector coil. It can also be used in accordance with application method spiral bladed steel piped Coils. In the applications where the heating is provided by electrical resistants, it is used the spiral Coils in order to raise up the efficiency.



Tangential Fans

It is used in forced convection floor convectors low sound levels. The fans working with 24V are two type. It can also be used fans working with 230V.

C1/C2/C3/C4 Serial Natural and Forced Convection Floor Convectors (without fan)

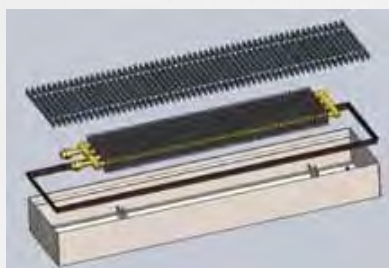
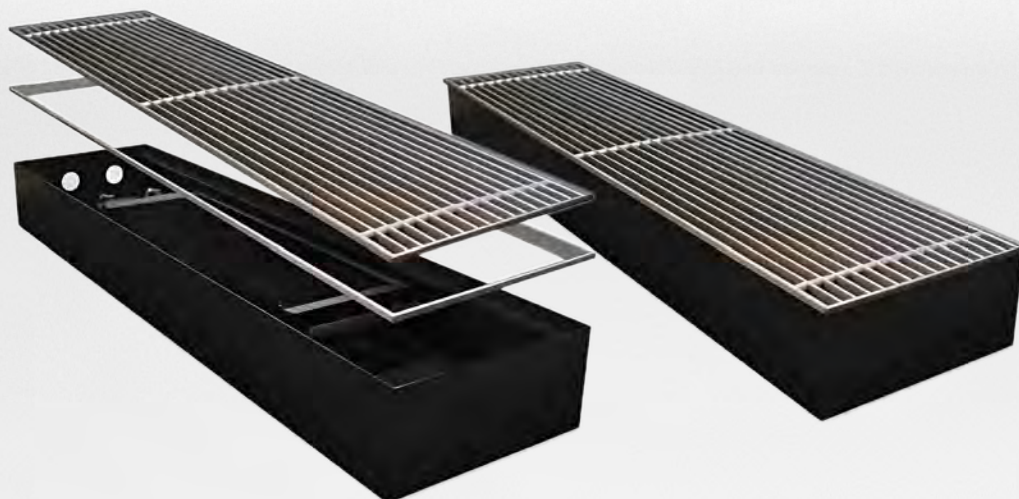

Natural convection type floor convectors can be used in showrooms, winter gardens, closed-top swimming pools, gymnasiums, business centers, houses, and especially in anywhere having glass facades, in order to increase the comfort conditions. It consists of aluminium casing, copper pipe-aluminium bladed coil, linear grille that is parallel to short edge or long edge and frame.



Generally as a secondary heating system depending upon the heating needs of the environment, it can bring the environment to the required comfort conditions. They can be placed in front of the windows in the places heated by radiator or central heating system.



In glass facades, by being used in front of the windows where the most of heat loss of the environment is happened, it helps heating the environment and avoids the steam appear on the glass surface. It can be used thermostatic or motorised vain in coil entrance. The room temperature can be stabilised in the desired degrees by room thermostad by using motorised vain where there are more than one vain in the same zone.

C1/C2/C3/C4 Serial Natural and Forced Convection Floor Convectors (without fan)

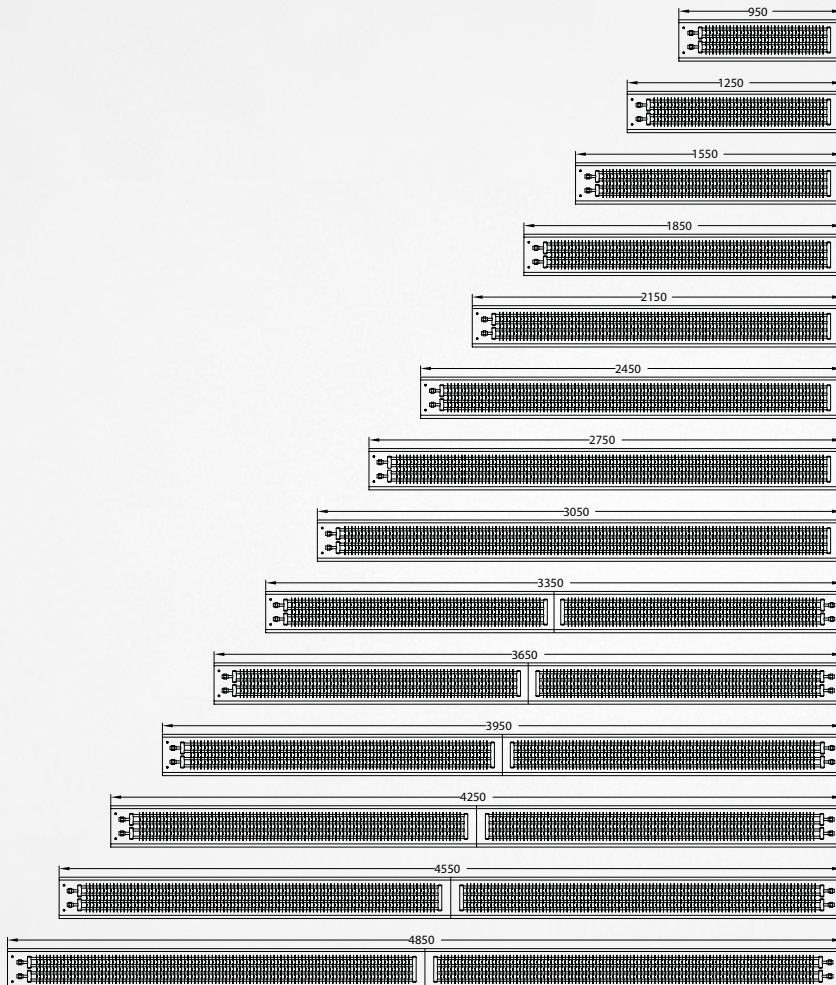
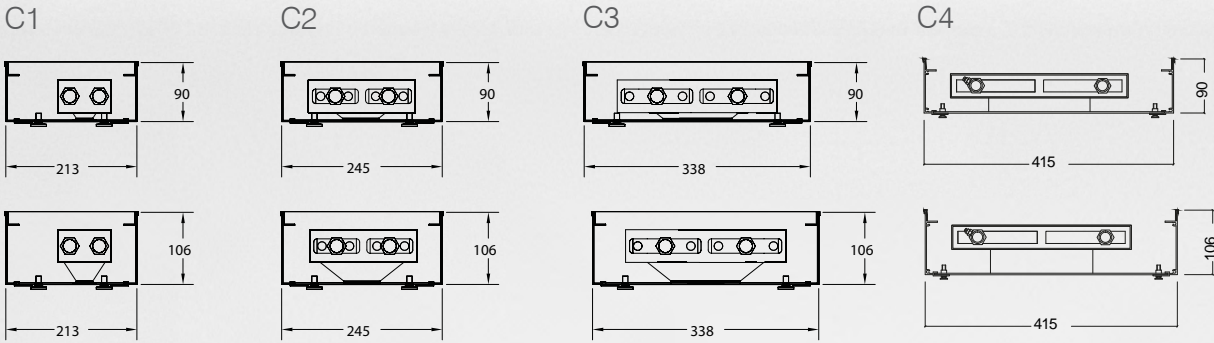

Case serpentine layout. All table dimensions are in mm.

C1-D/C2-D/C3-D Natural Convection Type Floor Convectors (Without Fan)

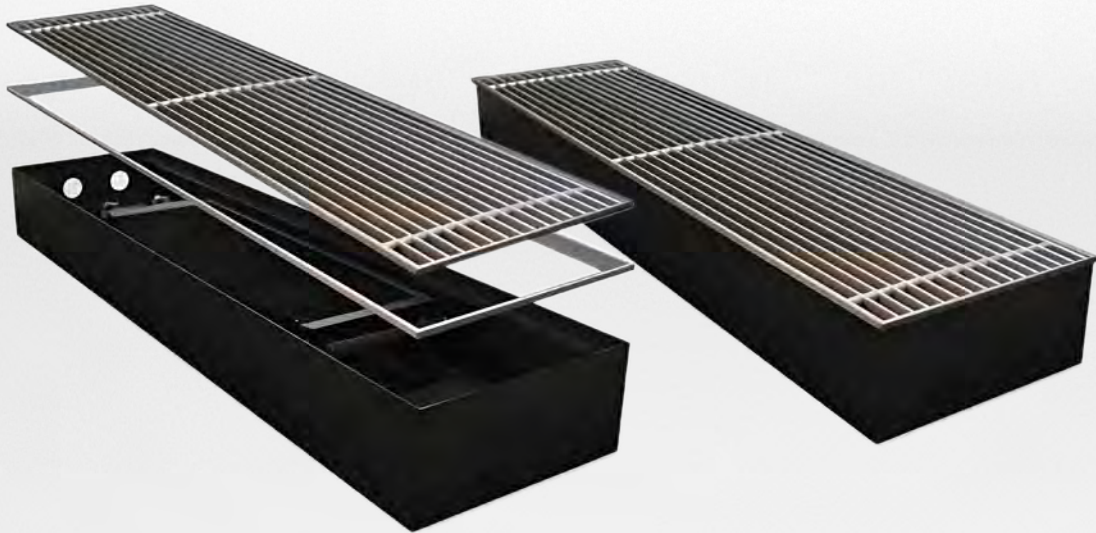

They are used where the natural convection type floor convectors are selected as the primary heating system. They have bigger heating capacity rather to K serial convectors that are in the same width.



Construction structure is as it is in K serial, but only the coil type differs. The transfer surface area and volume of the coil that is being used, increase the average heat transfer.



They can be preferred in places having high ceiling and big amount of glass surface. All the heating needs of the big surfaces such as showrooms, exhibition centers and museums can be met without the need of a secondary heating system.

C1-D/C2-D/C3-D Natural Convection Type Floor Convectors (Without Fan)

C1-D

C2-D

C3-D

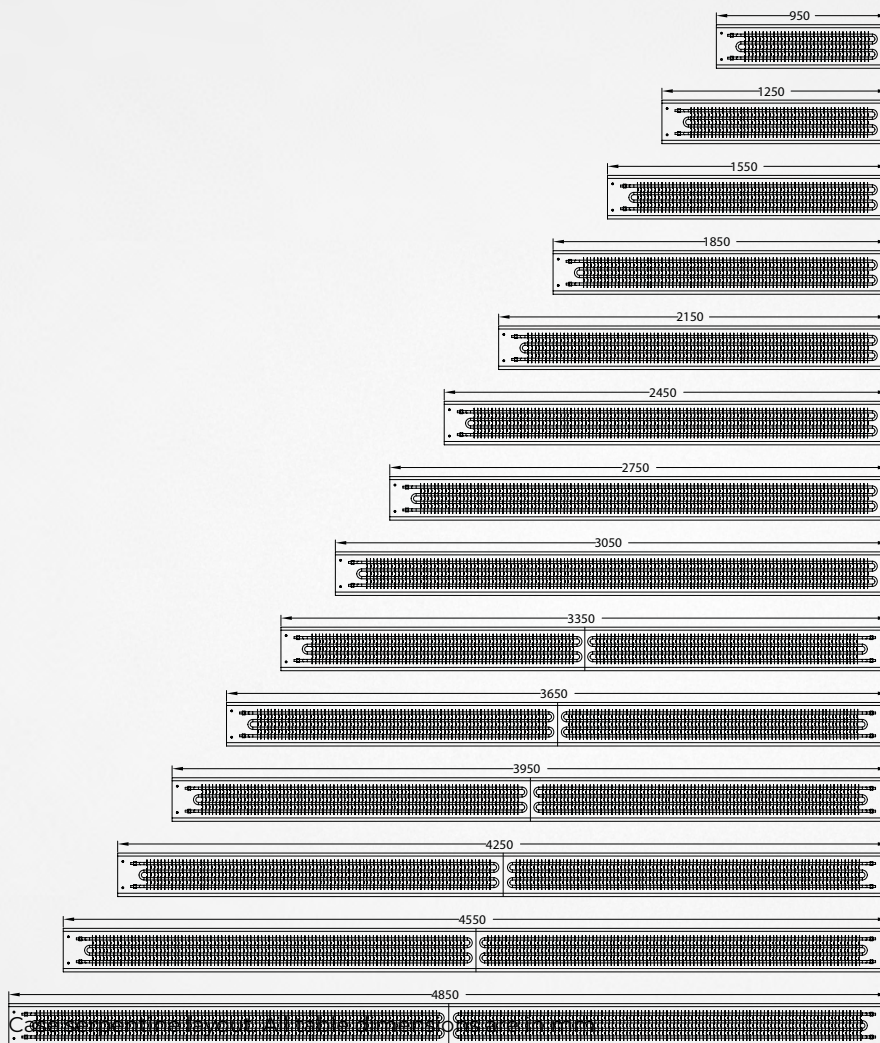
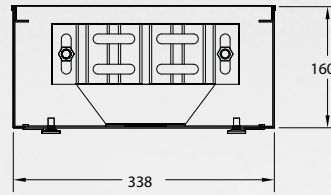
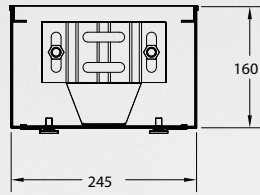
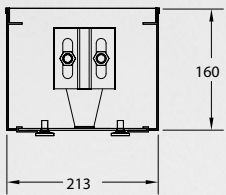
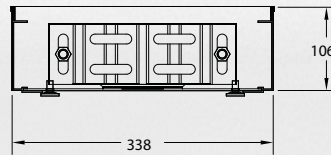
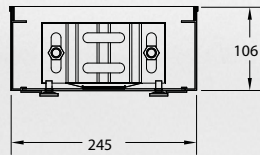
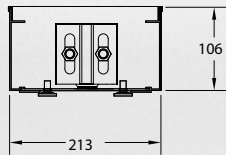

Forced Convection Type (With Fan)



CFT1/CFT2/CFT3 Serial Forced Convection Type Floor Convectors (With Fan)

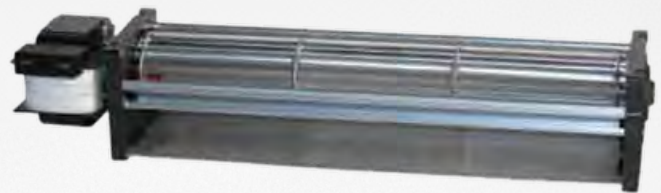

The tangential fans that are being used operate in low sound levels. They can be operated in 2 grades. The tangential fans with single or double rotor are used depending on their convector length.

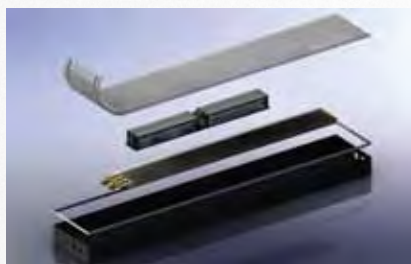

The forced convection type floor convectors can be used as the secondary heating system as well as the primary. With a fan assembly, high heating capacities are provided.



As in products without fan, the construction structure is in aluminium casing including tangential fan additional to heating coil and linear grille.

CFT1/CFT2/CFT3 Serial Forced Convection Type Floor Convectors (With Fan)

CFT1

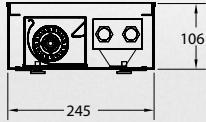

CFT2

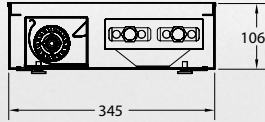

CFT3

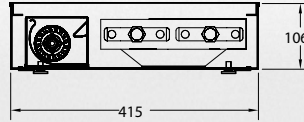

Case, fan, coil layout. All table dimensions are in mm.

CFT1-D/CFT2-D/CFT3-D Serial Forced Convection Type Floor Convectors (with Fan)

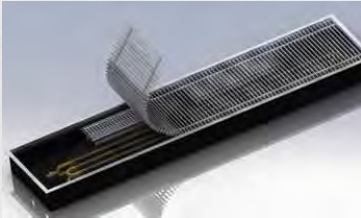

They can be used where it is needed higher heating capacity in shorter distance. In the circumstance of the fan is not working, they maintain the temperature of the environment by enabling high-capacity heating.

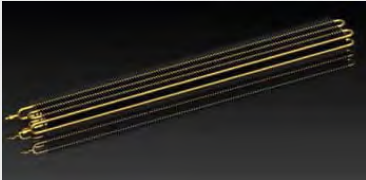

They provide the heating of the places to be used for the first time and to be heated in short time with a high performance. .



Their only difference from KFT serial types, is the usage of the coils with bigger heating surface. Like the other types, linear grilles in anodised aluminium or painted in desired color can be used.

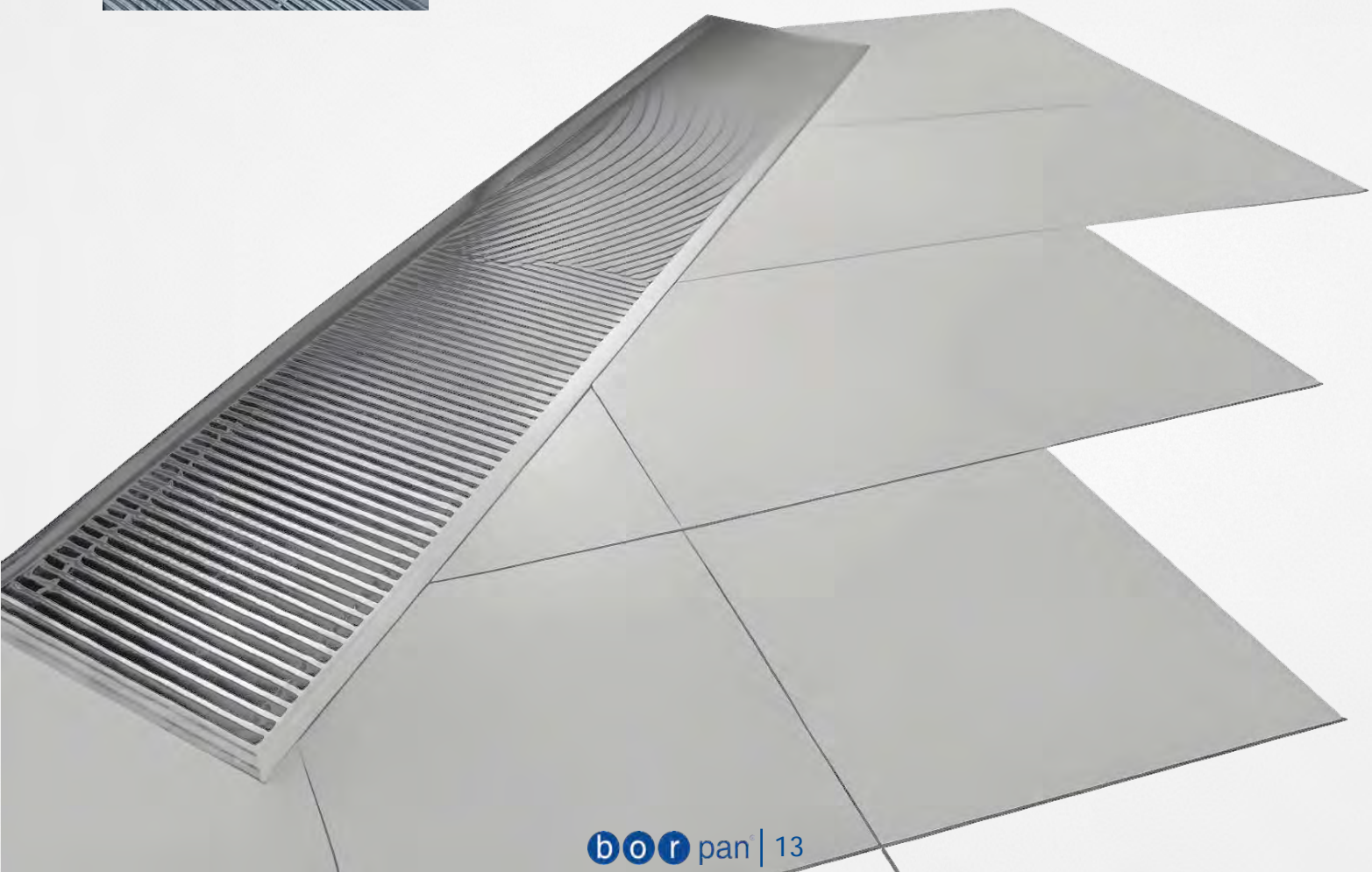

CFT1-D/CFT2-D/CFT3-D Serial (h:160mm) Forced Convection Type Floor Convectors (with fan)

CFT1-D

CFT2-D

CFT3-D

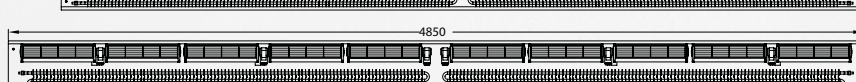
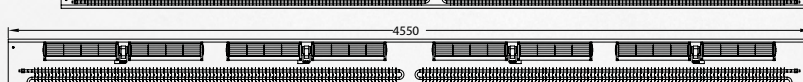
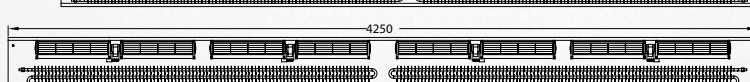
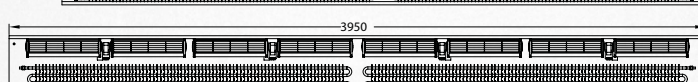
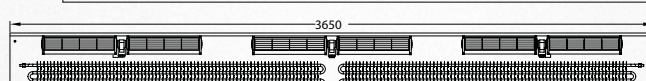
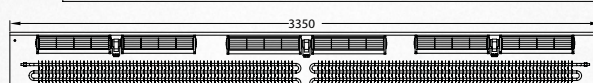
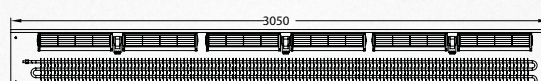
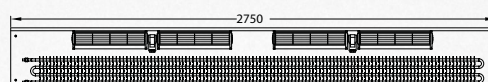
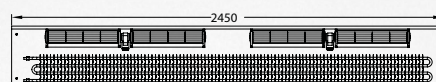
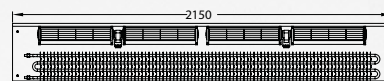
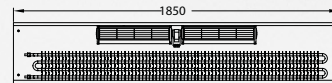
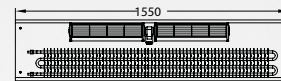
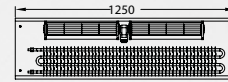
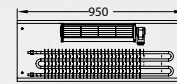
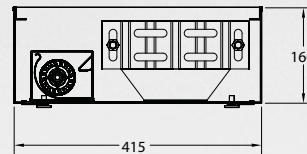
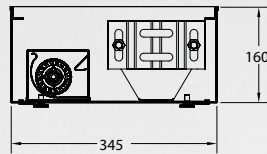
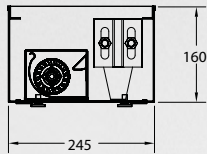
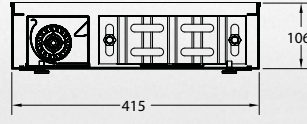
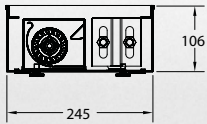

Case, fan, coil layout. All table dimensions are in mm.

CFTC1-HC/CFT2-HC/CFT3-HC Serial (4 Pipes) Forced Convection Type Floor Convectors (with Fan)

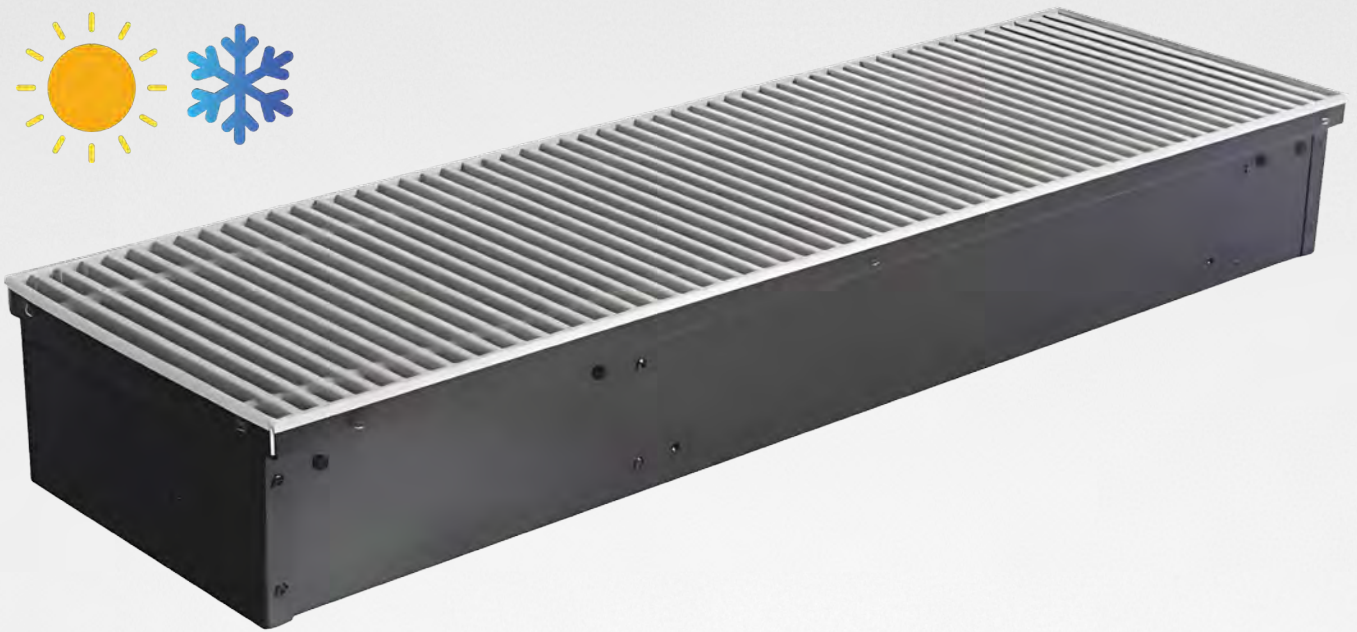
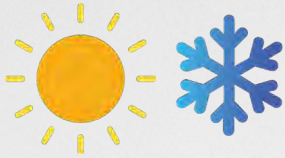

Forced convection type floor convector is preferred in case it is needed also cooling the environment. Heating and cooling circuits are independent to each other. Upon the necessity, the convectors that are produced in 3 different types, The only difference from the other types is their having double Coils and condensation pan. 4-piped floor convectors are produced with fan standardly. The convector capacity changes depending on the cold water regime that is used in the cooling system.

CFT1-HC/CFT2-HC/CFT3-HC Serial Forced Convection Type Floor Convectors (with Fan)

CFT1-HC

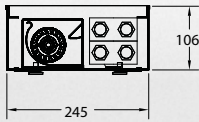

CFT2-HC

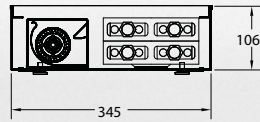

CFT3-HC

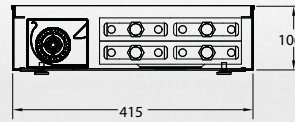

Case, fan, coil layout. All table dimensions are in mm.



Office : İvedik OSB Mahallesi Maxivedik Plaza 1122 Cad.
No:20/48
Yenimahalle Ankara TÜRKİYE
+90 312 386 00 55 | info@bedisa.com.tr
www.bedisa.com.tr

Factory : Erenler OSB Mahallesi Mehmet Altınsoy Bulvarı
No : 20 Aksaray TÜRKİYE